

BRUSHED GOLD THERMOSTATIC REMOTE CONTROLLED LED MUSICAL RECESSED CEILING MOUNT RAINFALL MIST WATERFALL SHOWER SYSTEM WITH JETTED BODY SPRAYS AND HAND SHOWER SPECIFICATIONS

Shower Head

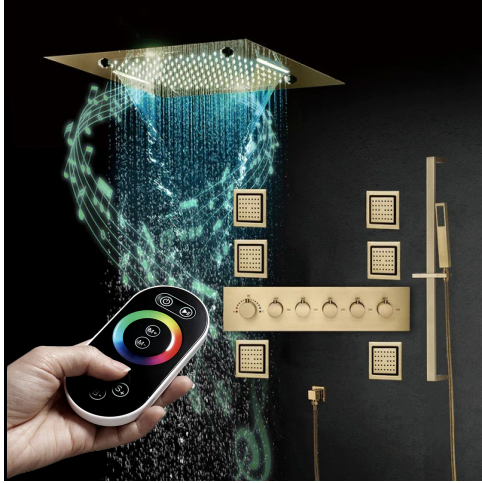

Shower Head 3 Functions: Waterfall, Rainfall & Mist

Shower head size: 20 x 20 inch

Each function run all together and separately

Music and LED light work by electronic

All Metal Material: Solid Brass; Stainless Steel (top showerhead, hose)

Shower Head Mounting: Flush on ceiling

Hand Spray Hose: 59 inch

Water flow: 2.5 GPM ~ 5.5 GPM

Water pressure: 0.3 MPA ~ 1 MPA

Water pipe lines: 3/4 inch water pipes for the hot and cold water mixer inlet, the others are 1/2 inch

304 Stainless Steel

Speaker×2 [500×500mm]

Mist×4

Waterfall×2

Rainfall

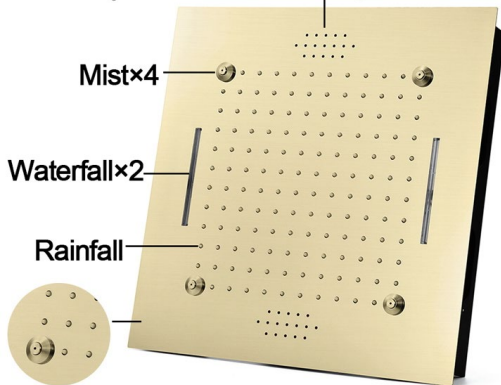

Water Pressure: 0.3-0.5MPA
Shower Flow Rate: 9-25L/min

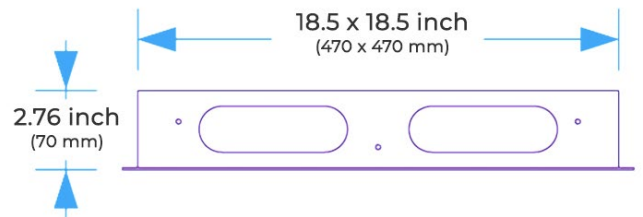
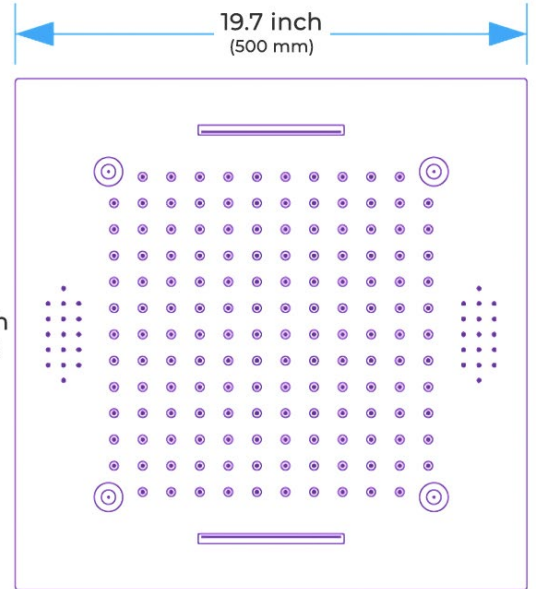

Product shown is only for installation display purpose



All dimensions and specifications are nominal and may vary. Use actual products for accuracy in critical situations.

Shower Mixer

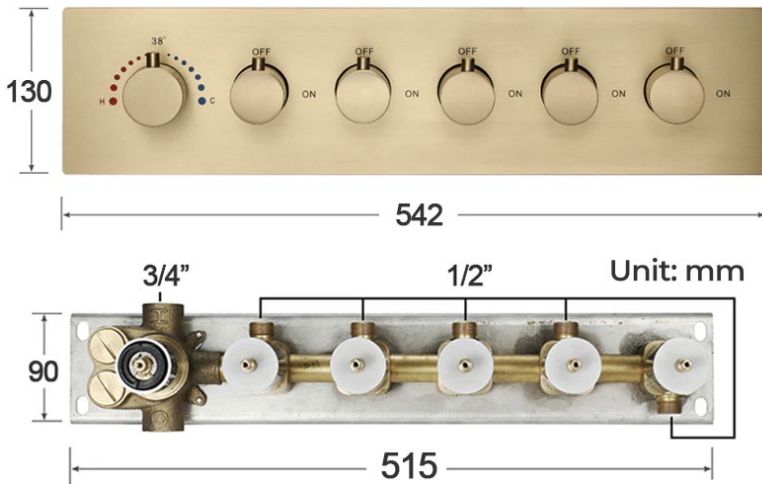

Product shown is only for installation display purpose

Shower Mixer Connections

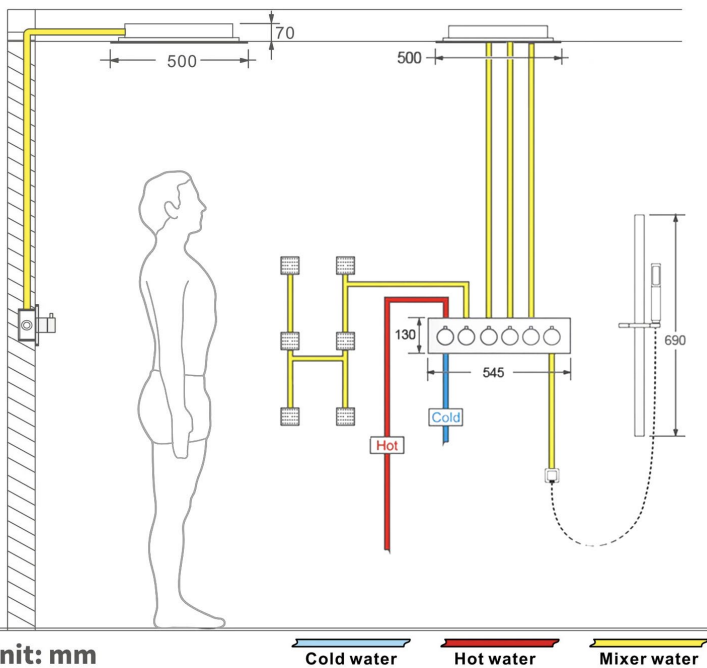

Hand Shower

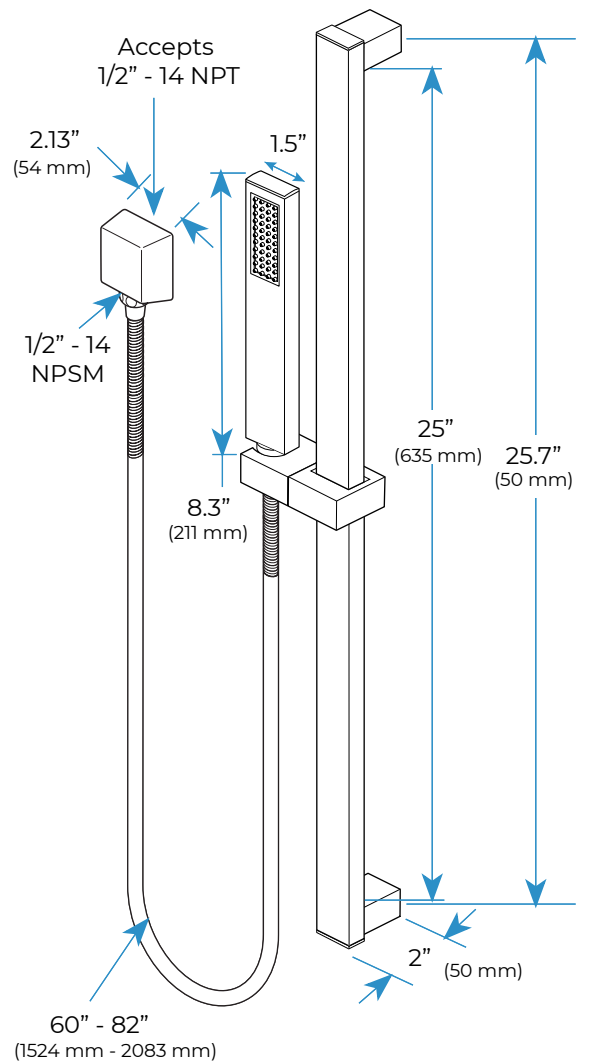

Body Jet

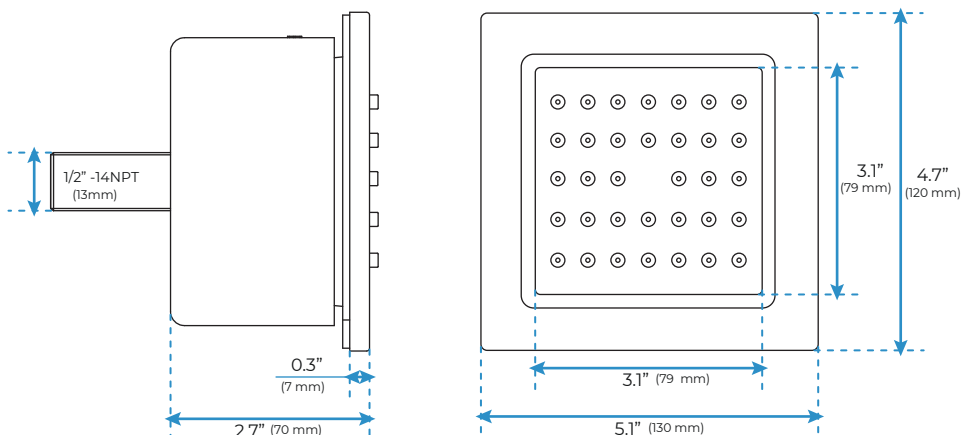

FEATURES

- Material: Brass
- Base Plate Height: 5-1/8"
- Base Plate Width: 5-1/8"
- Jet Surface Area: 3-1/8"
- Surface Depth: 1/4"
- Adjustment Angle: 5°
- Male NPT Connection: 1/2"
- Maximum Flow Rate: 2.5 GPM (9.5L/min) max @ 80 psi