

FONTANA COMMERCIAL AUTOMATIC TEMPERATURE CONTROL RENO DIGITAL TEMPERATURE DISPLAY HOT AND COLD COMMERCIAL SENSOR FAUCET IN CHROME INSTALLATION INSTRUCTIONS



BEFORE YOU BEGIN

Before you begin, please read the installation instructions below. Observe all local building and safety codes.

Unpack and inspect the items for any shipping damages. If you find damages, do not install.

Please note all products must be installed by a professional and certified plumber otherwise warranty might be voided.

POSSIBLE TOOLS REQUIRED*



Plumbers Tape

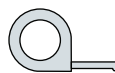

Tape Measure



Level



Adjustable Wrench



Hex Wrench



Thread Sealant



Drill



Pencil or Marker



Screwdriver

*not included

Technical Information

Power: DC:6V(4AA alkaline battery)
 AC:220V-240V; 50/60HZ
 Water Consumption: 0.05Mpa-0.6Mpa
 Detection Zone: 16-32 cm or adjustable
 Motor valve lifespan: up to 500000 flushes
 Battery lifespan: 100000 cycles
 Static Power Consumption: 0.36mw
 Working Power consumption: 0.5mw
 Inductive Opening Time: < 1 second
 Inductive Closing Time: < 2 second
 Dia.of inlet / outlet pipe: G1/2"
 Flux: $\geq 0.07L/S$
 Temperature: 0.1-50°C
 Dia of installing faucet: 33~35mm

Faucet Size

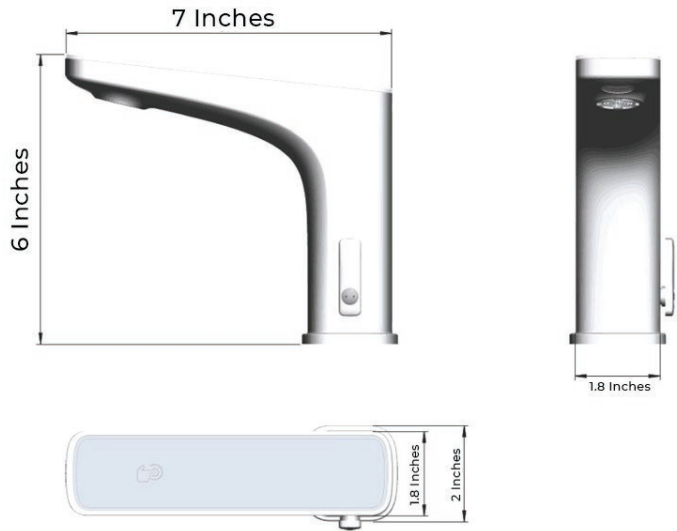

Faucet Deck Mount Installation

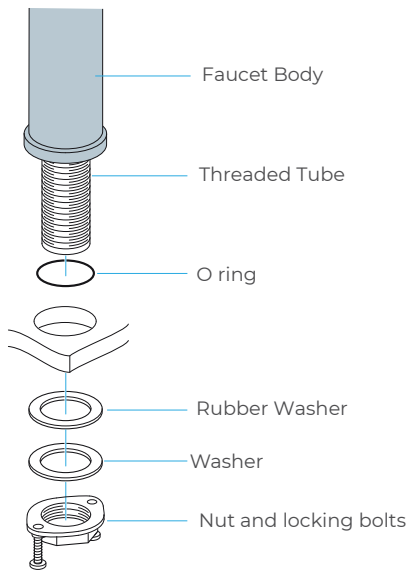

Water Pipe Connection

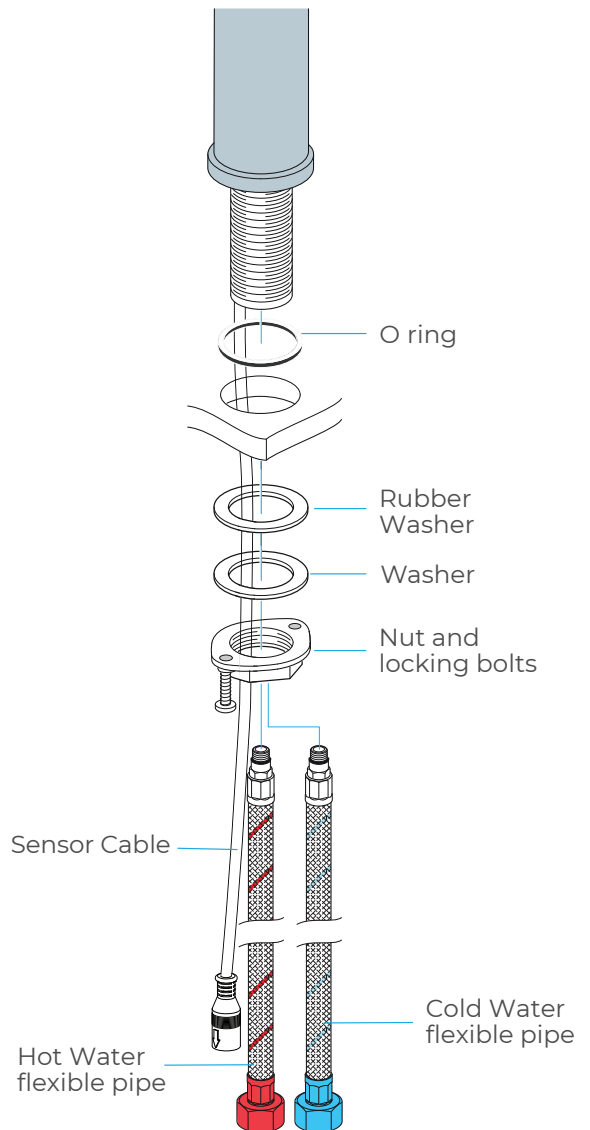

Hole Size Chart

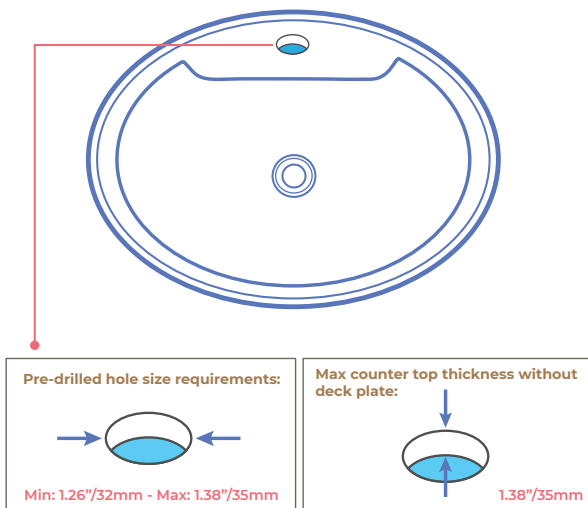

All dimensions and specifications are nominal and may vary. Use actual products for accuracy in critical situations.

Detailed Faucet Installation Instructions

1.

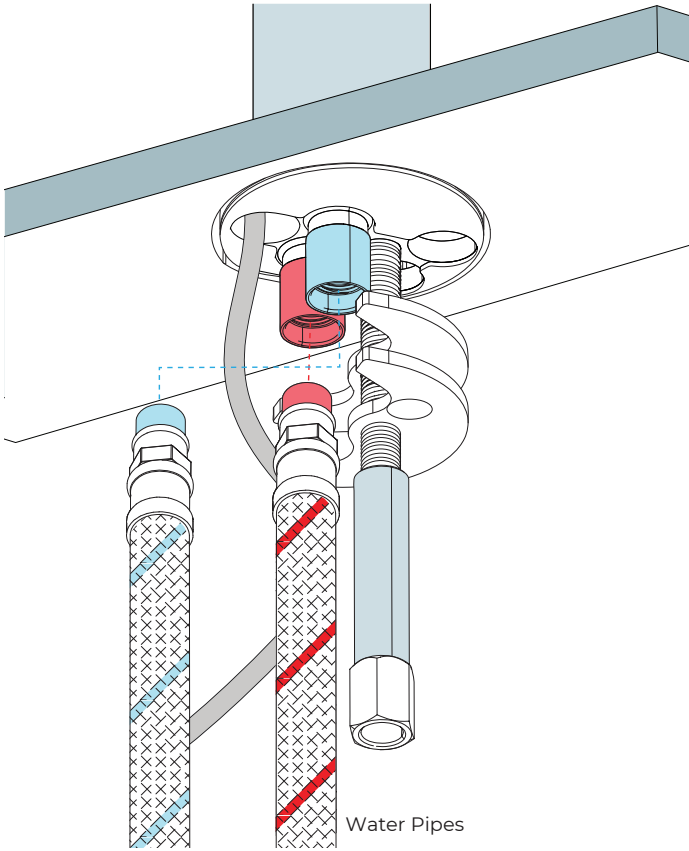

2.

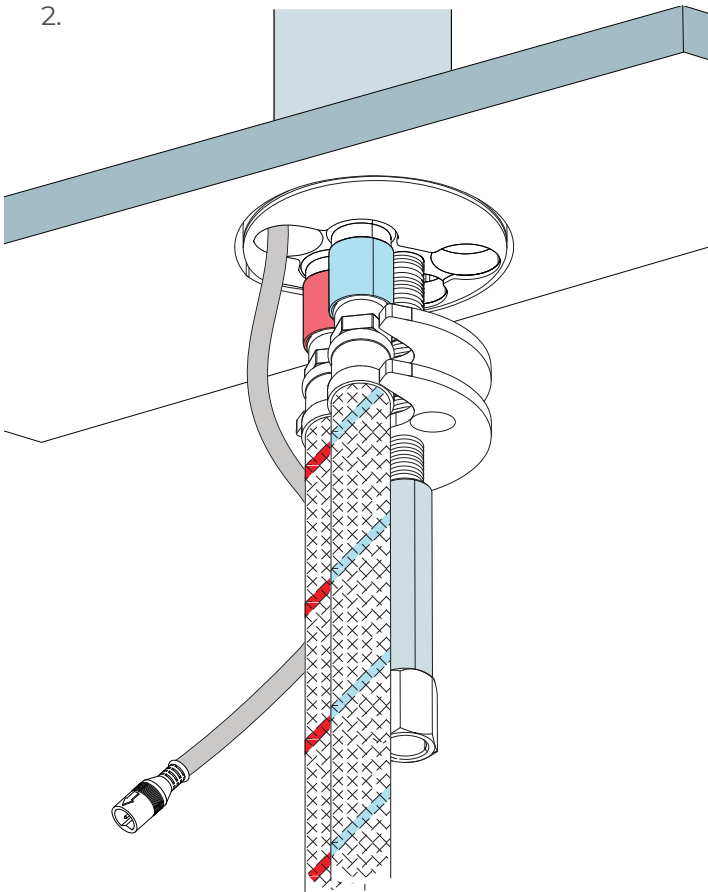

3.

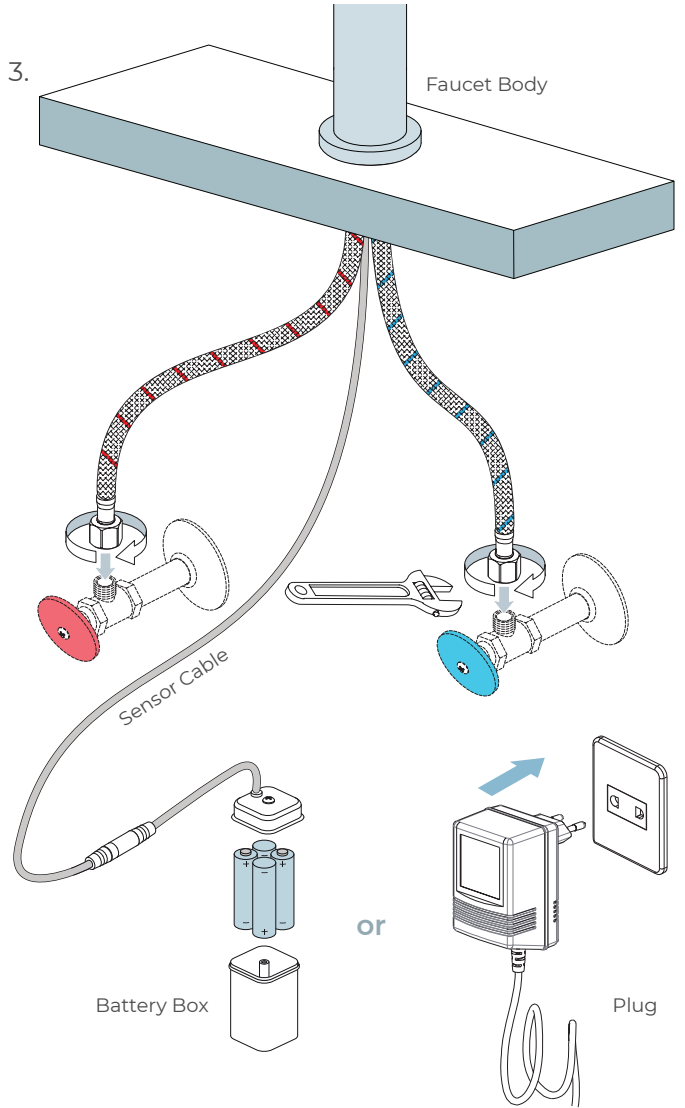

4.

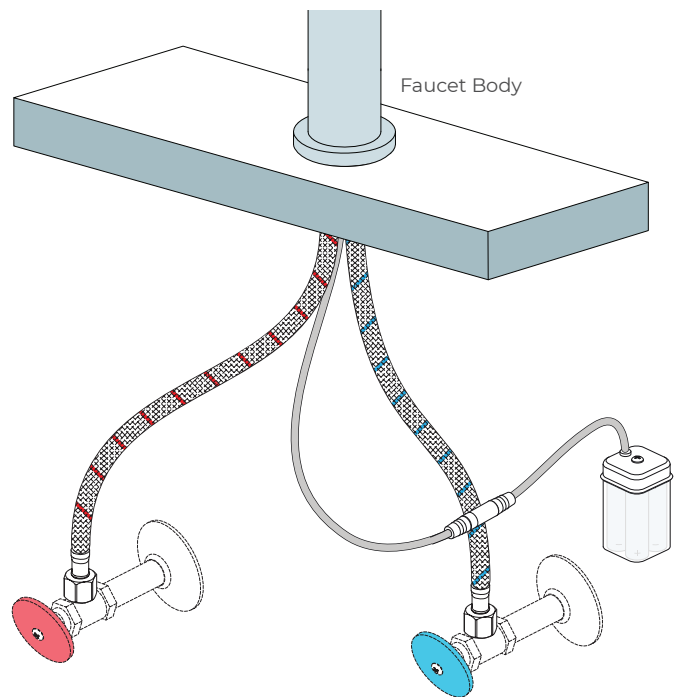

Sensor Range

This sensor faucet can automatically adjust the inductive range within 10 seconds of electrification. Do not use inductor during this period so that the inductor can automatically adjust to a suitable inductive range.

Set Water Flow Time-Out

The sensor faucet will shut off the water when washing time exceeds 1.5 minutes. If follow-up washing is needed, re-induce after removing hands for 2 seconds.

Notes

1. Please use the AA type alkaline battery (1.5v for each).
2. Place batteries into each indicated spot. Utilizing new batteries of the same brand is best. If mixed, it could shorten the battery life to 1-2 months.
3. After installation of the battery, the solenoid valve will do its self-testing.
4. Wait ten seconds for power to be applied and allow the sensor faucet to self-adjust sensor distance. Do not use your faucet during this time.
5. If the sensor distance is too short, please move the barrier from the faucet for 5-6 mins and allow the sensor faucet to adjust to normal.
6. If the sensor distance is too far, and water flows continuously, the sensor faucet will self-adjust the distance after 5 mins.

Low Battery Warning

When the batteries run low and the power falls below 3.9V the sensor light will flicker to indicate the batteries are running low and need replacing.

When the batteries are exhausted the sensor light will not light up.

Water Efficient

When the users hands enter the sensing range, the indicator light in the sensor will illuminate. Water will flow out immediately until the user draws their hands back from the sensor.

Temperature Control

Manual temperature control handle allows users to set preferred temperature.

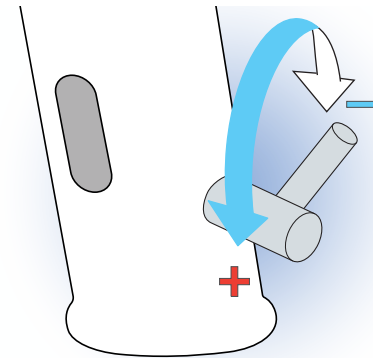
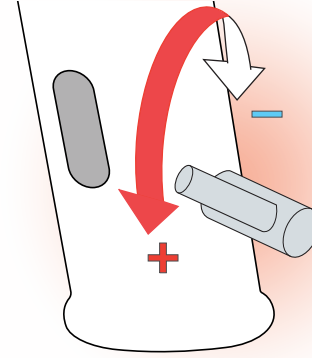

Water Temperature Adjustment Switch

Sensor Faucet & Soap Dispenser Placement

Incorrect Placement

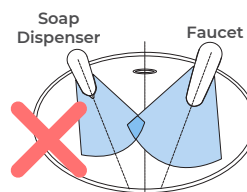

Keep sensor range adjustment within 4 inches away from center of spout. This can only be done with optional remote control.

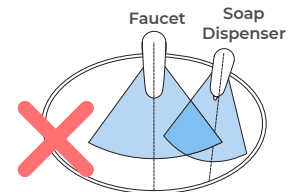

Installing electronic soap dispenser & faucet with intersecting centerline might lead to accidental activation of either or both.

Correct Placement

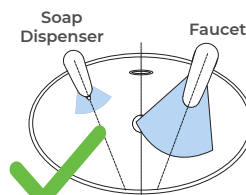

Keep sensor ranges factory preset.

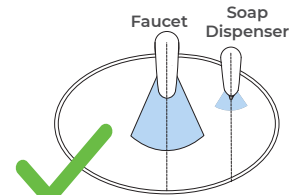

Keep soap spout & faucet centerline parallel.

Waterpipe Instructions

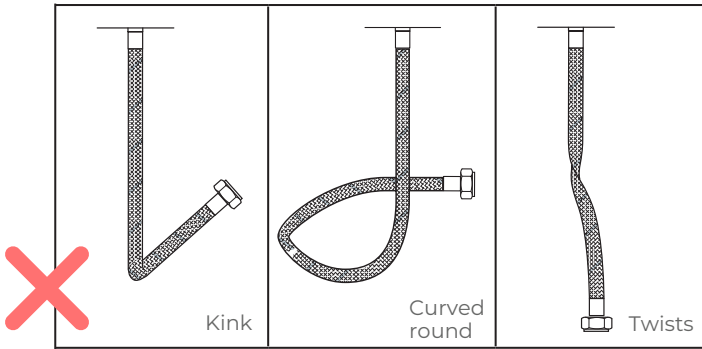
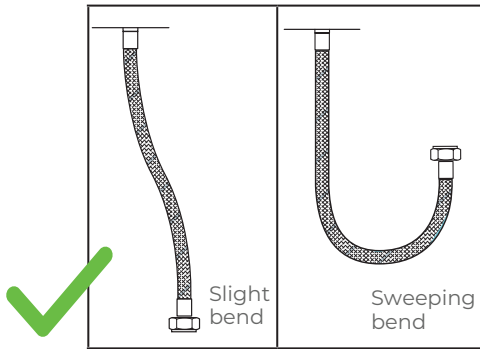

General Information

Our sensor spouts have a non-touch control which uses infrared sensing technology to detect human presence. Once detected, the spout instantly dispenses water and automatically stops once the user moves their hands away to eliminate unnecessary water wastage, whilst creating a more hygienic washroom solution.

All products manufactured and supplied by BathSelect are safe and comply to legislative requirements. Providing they are installed correctly and receive regular maintenance in accordance with these instructions your user experience will not be affected.

Hygienic

The proximity sensor faucet removes the need to touch the faucet body, reducing the spread of germs and the chance of cross-contamination.

Care & Cleaning

- Wipe faucet down with a soft cloth to prevent mineral build-up and water-spotting. Should spotting occur, remove water spots with warm water and soft damp cloth.
- Wipe away any debris adhering to the spout or sensor.
- Wipe away debris with a damp cloth containing a suitable amount of neutral dishwashing detergent. Then wipe clean with a damp cloth.
- When cleaning around the sensor, careful not to scratch the surface of the sensor window.
- Do not use detergent that might damage the surface of spout. These include:
 - Detergents containing acid, chlorine bleach or alkali.
 - Detergents that are coarse granules in nature, such as polishing powder.
 - Solvents such as paint thinner or benzene.
 - Abrasive aids such as nylon scrubbers/brushes, steel wool, etc.

